





323 □ Z1 S □ □ 7

- A4 = 4,5
 - A5 = 5,5
 - A6 = 6,5
 - A7 = 7,5
 - A8 = 8,5
 - A9 = 9,5
 - B0 = 10,5
 - B1 = 11,5
 - B2 = 12,5
 - B3 = 13,5
 - B4 = 14,5
 - B5 = 15,5
 - B6 = 16,5
 - B7 = 17,5
 - B8 = 18,5
 - B9 = 19,5
 - C0 = 20,5
- H_{cm}**









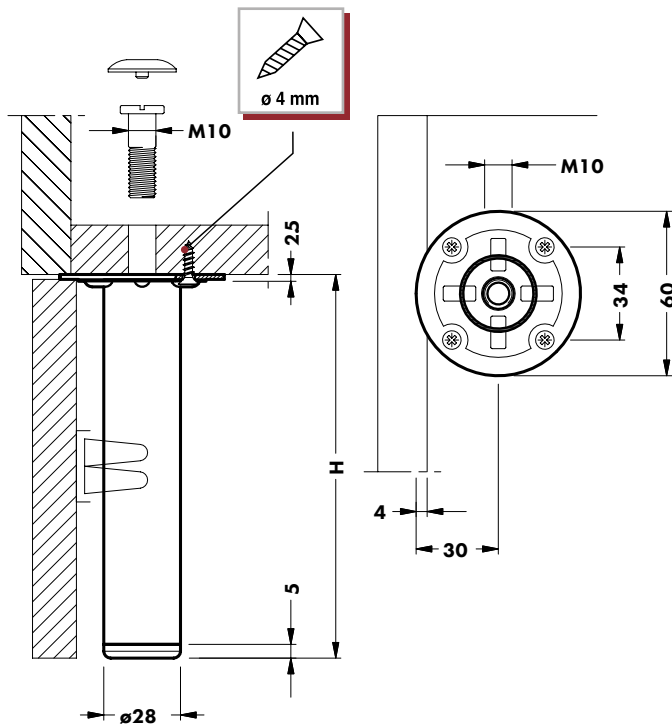

- | | |
|---|---|
| 0 | 0 |
| 1 | 1 |
| 2 | 2 |
| 3 | 4 |
|  | 5 |
|  | |



+15mm 0mm		Ø28mm	
--------------	--	-------	---

ABS	Fe
-----	----



9		1 868 00 Z1 S1 00  666												
		2 868 00 Z1 S2 00  666												
		3 868 00 Z1 S3 00  667												
9		1 810 37 01 00 00  656												
		2 810 37 02 00 00  656												
		4 810 37 04 00 00  656												
		5 810 37 55 00 00  656												
		9		<table border="1"> <tr> <td>202 600</td> <td>203 601</td> <td>204 602</td> <td>225 606</td> </tr> <tr> <td colspan="2">H 7,5-20,5</td> <td colspan="2">H 8,5-20,5</td> </tr> </table> <table border="1"> <tr> <td>226 607-609</td> <td>228 611</td> <td>230 612-613</td> <td>235 614</td> </tr> </table>	202 600	203 601	204 602	225 606	H 7,5-20,5		H 8,5-20,5		226 607-609	228 611
202 600	203 601	204 602	225 606											
H 7,5-20,5		H 8,5-20,5												
226 607-609	228 611	230 612-613	235 614											