

823 AS Z1 15

□ □
DX
SX







FOR YOUR SAFETY WARNING

kg ?
www.camar.it/warning

3D **10 mm** **10 mm** **4** 



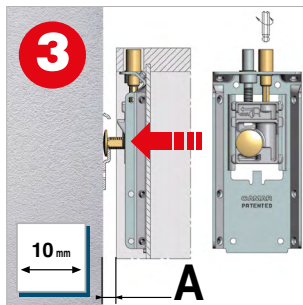
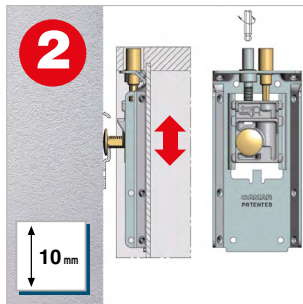
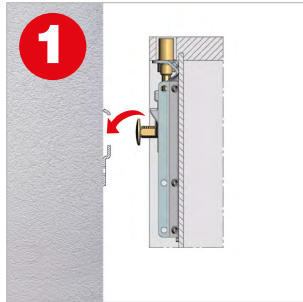

Fe **ZAMAK**



 50  1800  100









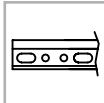

A = 4-10 mm



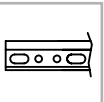

A = 0-4 mm

-   After assembly, verify that the anti-drop system has been activated.
-   Verificare dopo il montaggio l'avvenuta attivazione del sistema antisgancio.

9  **BRACKET** **PLATE**
BP
20-30mm **877 A5 Z1 DP 60**  677

9  **BRACKET** **PLATE**
BP
20mm **877 A5 PZ 00 60**  679
877 A5 Z1   679
877  **Z1**   680

9  **BRACKET** **PLATE**
BP
25mm **877 A5 PZ LA 60**  678

9  **810 00**  **28 16**  647
810 15  **06 08**  652