

# 446 □ P2 OZ 02

- 12
- 13
- 14
- 15
- 16

Hcm



+50mm  
-5mm

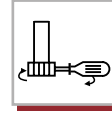



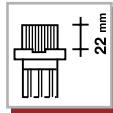





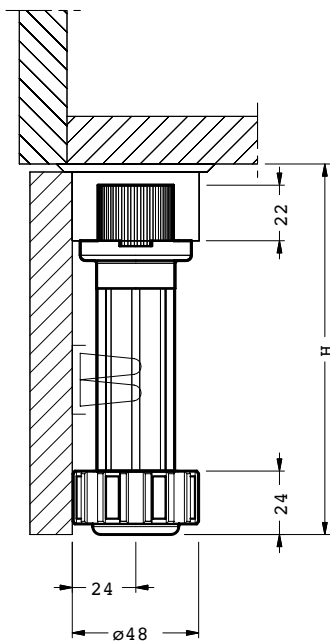

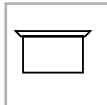

Ø28mm



ABS

 3000



|   |  |   |   |   |   |
|---|--|---|---|---|---|
| 2 |  |                | <b>840</b><br> |   |   |
| 9 |  | <b>202</b><br> | <b>203</b><br> | <b>204</b><br> | <b>225</b><br> |
|   |  | <b>226</b><br> | <b>228</b><br> | <b>230</b><br> | <b>235</b><br> |